

Space

Kitchen Mixer

Article no.: 100100000
Finish: Chrome
Series: Space

EAN no.: 5708516728740



Standard features:

- 1 handle
- 120° swivel limitation
- Ceramic cartridge
- Scalding protection
- Water consumption max. 13 l
- Eco-Save water saving feature

Product features

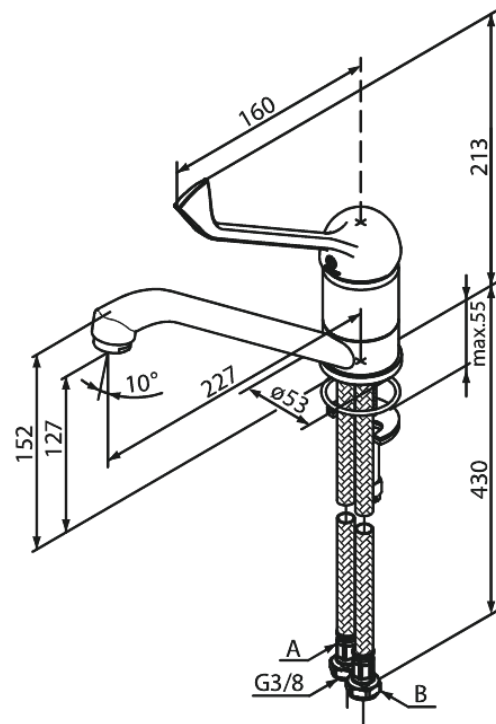

FM Mattsson Denmark ApS
Hvidkærvej 48, 5250 Odense SV, DK-56416218

+45 88 33 00 34 danmark@fmmattssongroup.com

Mere information på damixa.com

damixa