

Slate

Kitchen Mixer

Article no.: 650660000
Finish: Chrome
Series: Slate

EAN no.: 5708516830603



Standard features:

- 1 handle
- 120° swivel limitation
- Ceramic cartridge
- Cold-start
- Rub-clean aerator
- Scalding protection
- Water consumption max. 8 l/min
- Eco-Save water saving feature

Product features

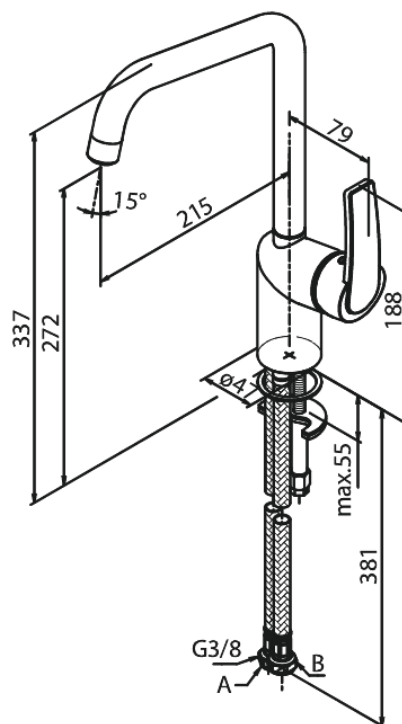

FM Mattsson Denmark ApS
Hvidkærvej 48, 5250 Odense SV, DK-56416218

+45 88 33 00 34 danmark@fmmattssongroup.com

Mere information på damixa.com

damixa