

Pine

Kitchen Mixer

Article no.: 170010000
Finish: Chrome
Series: Pine

EAN no.: 5708516814689



Standard features:

- 1 handle
- 120° swivel limitation
- Ceramic cartridge
- Cold-start
- Rub-Clean
- Scalding protection (38°C)
- Eco-Save water saving feature
- 8/l min aerator
- Dishwasher Shut off valve

Product features

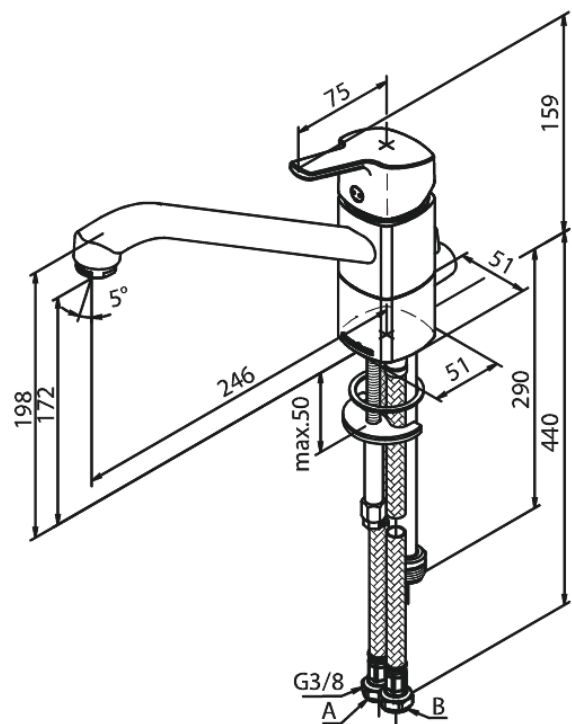

FM Mattsson Denmark ApS
Hvidkærvej 48, 5250 Odense SV, DK-56416218

+45 88 33 00 34 damixa-international@fmmattsongroup.com

Mere information på damixa.com

damixa