

Slate

# Kitchen Mixer

**Article no.:** 650660000  
**Finish:** Chrome  
**Series:** Slate

**EAN no.:** 5708516830603



## Standard features:

- 1 handle
- 120° swivel limitation
- Ceramic cartridge
- Cold-start
- Rub-clean aerator
- Scalding protection (38°C)
- Water consumption max. 8 l/min
- Eco-Save water saving feature

## Product features

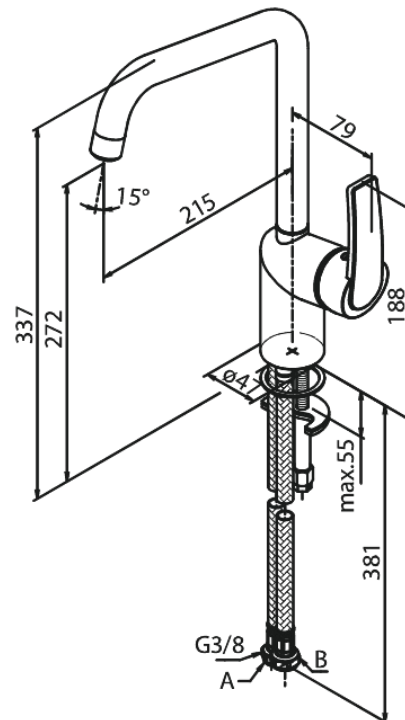
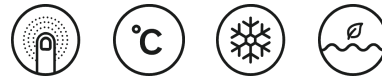

FM Mattsson Denmark ApS  
Hvidkærvej 48, 5250 Odense SV, DK-56416218

+45 88 33 00 34 [damixa-international@fmmattsongroup.com](mailto:damixa-international@fmmattsongroup.com)

Mere information på [damixa.com](http://damixa.com)

**damixa**